

## WESSEX MODUMAX Mk3

### INSTRUCTIONS FOR USE

**Note:-** This boiler is for use only on Natural Gas (2nd Family) I<sub>2H</sub> or LPG Propane I<sub>3P</sub>. Only a competent person must carry out any adjustments.

**WARNING:** All installations MUST conform to the relevant Gas Safety and Building Regulations. It is law that all gas appliances are installed and maintained by competent persons in accordance with the above regulations. This appliance must







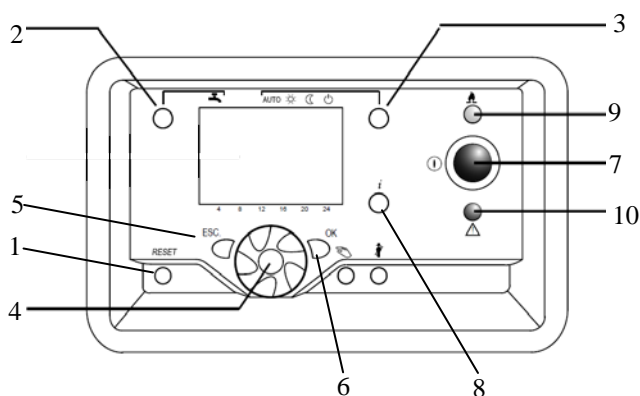

only be used for the purpose and under the conditions, for which it is designed.

The boiler condense outlet shall not be modified or blocked.

Electrical supply to the boiler MUST be suitably earthed.



**Figure 1 - Boiler Control Panel Fascia**

Button	Symbol	Function
1		RESET
2		DHW
3		Selection of Heating Mode
	AUTO	Automatic (time control)
		Continuous 'Normal' temperature
		Continuous 'Reduced' setback temperature
		Standby - boiler off.
4		Rotary knob function control
5		ESC
6		OK
7		ON/OFF
8		INFO
9		Green LED (flame present)
10		Red LED (fault detected)

The boiler display screen provides various levels of access to view and change the performance parameters of the boiler.

The User can change parameters relating to time clock, boiler program timings and boiler temperature setpoint.

In addition, the User can view performance data and reset specific lockouts. Should a lockout occur, a code will be displayed on the screen. A red LED is displayed constantly when a non-blocking fault is detected (following correction of the fault, the LED goes off). The LED flashes when a blocking fault is detected (in this case, the LED goes off after the fault has been corrected and the reset button on the interface has been pressed),

**Should a fault code appear which cannot be reset, or a fault code repeatedly occurs, contact Hamworthy Heating for assistance. Do not continue to operate or use the boiler as this may cause damage to the controls.**

## **LIGHTING INSTRUCTIONS**

Carry out the following procedure for each boiler

Ensure the electrical mains supply to the boiler module is switched on and that any external controls are calling for heat (Time clock, BMS etc.).

Depress blue On/Off button (7) The button will illuminate and the screen will update data. When the update is complete the screen will enter normal boiler mode.

### **To set Time and date**

Press **OK** – To enter **PROG** screen - Time of day and date will be highlighted on screen.

Press **OK** – Hours/minutes will be shown on screen.

Press **OK** – Hours will flash – Use rotary knob to enter the hours required – Press **OK** to enter

Press **OK** – Minutes will flash – Use rotary knob to enter minutes required – Press **OK** to enter

Turn rotary knob – Day/month will be shown on screen

Press **OK** – Month will flash – Use rotary knob to enter month required – Press **OK** to enter

Press **OK** – Day will flash – Use rotary knob to enter day required – Press **OK** to enter

Turn rotary knob – Year will be shown on screen.

Press **OK** – Year will flash – Use rotary knob to enter year required – Press **OK** to enter

When finished press **ESC** to return to **PROG** screen – Press **ESC** to return to Main screen

### **To set time programme for heating circuit.**

Press **OK** – to enter **PROG** screen – Turn rotary knob to highlight Time prog heating circuit 1

Press **OK** – Turn rotary knob - 1st phase on will be shown on screen

Press **OK** – Time will flash – use rotary knob to enter time required – Press **OK** to enter

Turn rotary knob – 1st phase off will be shown on screen.

Press **OK** – Time will flash – use rotary knob to enter time required – Press **OK** to enter

Repeat process for 2nd and 3rd phases.

When finished press **ESC** to return to **PROG** screen – Press **ESC** to return to Main screen.

### **To set boiler flow setpoint for heating circuit 1**

Press **OK** – to enter **PROG** screen – Hold **INFO** button for 5 seconds

Use rotary knob to select **ENGINEER** -Press **OK**

Use rotary knob to select **Heating Circuit 1**- Press **OK**

Use rotary knob to select line **741**

Press **OK** – Setpoint will flash – Use rotary knob to set value required – Press **OK** to enter

When finished press **ESC** to return to **PROG** screen – Press **ESC** to return to Main screen.

## **To light the boiler**

Use the mode button (3) to select the desired operating mode. The boiler should go through it's sequence and light.

**If sequence does not begin, check all external controls and safety interlocks are correct.**

### **Lockouts**

Should a lockout occur, a code will be displayed on the screen.

A red LED is displayed constantly when a non-blocking fault is detected (following correction of the fault, the LED goes off).

The LED flashes when a blocking fault is detected (in this case, the LED goes off after the fault has been corrected and the reset button on the interface has been pressed),

**Should a Overheat lockout occur, a code will be displayed on the screen. The overheat thermostat will automatically re-set after sufficient temperature drop. To reset an Overheat condition, the boiler must be allowed to cool down. The reset button (1) must be depressed to clear the lockout condition.**

If the problem persists, seek expert advice from your installer or Hamworthy Heating Ltd.

### **Shutting Down the Boiler**

To shut the boiler off for short periods i.e. 2 to 3 days, carry out the following procedure for each module of the boiler -

Push the Mode button (3) until the Standby mode is selected

Alternatively the boiler can be put into setback operation by selecting the 'Reduced' mode.

**Note:-** During periods of intense cold weather, do not switch off the boiler module electrical mains supply, this will permit the system frost thermostat to function and protect the system.

To shut the boiler off for longer periods i.e. during summer periods, carry out the following procedure for each module of the boiler -

- 1) Switch the boiler module off as described above.
- 2) Depress the blue On/Off button (7)
- 3) Turn the main gas service valve off.

**Note:-** During periods of intense cold weather and with the boiler shut down for prolonged periods, the complete system should be drained (including the boiler). A notice should be placed on the boiler highlighting the fact that the system has been drained down.

The gas service valve should not be used, except in emergencies, or for long periods of shutdown or during servicing.

## Additional Safety Advice

- 1) Do not block or obstruct ventilation grilles.
- 2) Do not block or modify the condensate discharge.
- 3) If at any time a gas leak is suspected, turn OFF the gas supply - **DO NOT use a naked flame** - contact your nearest Gas Board immediately. Generally their telephone number can be located under **GAS** in your local telephone directory.
- 4) If you consider the boiler to be malfunctioning, turn it OFF and seek expert advice.
- 5) To ensure safe and efficient operation at all times, it is essential that the boiler is serviced regularly. Contact your installer or Hamworthy Heating Ltd. for advice.
- 6) Do not attempt to fire the boiler without first checking for correct water circulation. Consult the Installation Manual for information.

## Cleaning

To keep the casing clean wipe with a damp cloth, do not use abrasive cleaning materials. **DO NOT** use jets or sprays of water when cleaning area around boiler module controls fascia.

**Note:-** When cleaning the casing take care not to touch the flue of the appliance as this could be at a very high temperature and contact could cause injury.

## Servicing

This appliance should be serviced on an annual basis, preferably by a Hamworthy appointed person.

## List of Error codes

### **Error**

- 10 Outside temperature, sensor error 6
- 20 Boiler temperature 1, sensor error 6
- 20 Boiler temperature 1, sensor error 9
- 25 Boiler temperature, solid fuel, sensor error 6
- 26 Common flow temperature, sensor error 6
- 28 Flue gas temperature, sensor error 6
- 28 Flue gas temperature, sensor error 9
- 30 Flow temperature 1, sensor error 6
- 31 Flow temperature 1, cooling, sensor error 6
- 32 Flow temperature 2, sensor error 6
- 38 Flow temperature, primary controller, sensor error 6
- 40 Return temperature 1, sensor error 6
- 40 Return temperature 1, sensor error 9
- 46 Cascade return temperature, sensor error 6
- 47 Common return temperature, sensor error 6
- 50 DHW temperature 1 sensor error 6
- 52 DHW temperature 2 sensor error 6
- 54 Flow temperature DHW, sensor error 6
- 57 DHW, circulation sensor error 6
- 60 Room temperature 1, sensor error 6
- 65 Room temperature 2, sensor error 6
- 68 Room temperature 3, sensor error 6
- 70 Storage tank temperature 1 (top), sensor error 6
- 71 Storage tank temperature 2 (bottom), sensor error 6
- 72 Storage tank temperature 3 (center), sensor error 6

### **Error**

- 73 Collector temperature 1, sensor error 6
- 78 Water pressure, sensor error 6
- 78 Water pressure, sensor error 9
- 82 LPB address collision 3
- 83 BSB wire cross-sectional/no communication 8
- 84 BSB wire address collision 3
- 85 BSB RF communication error 8
- 91 Data overrun in EEPROM 3
- 91 Data overrun in EEPROM 6
- 91 Data overrun in EEPROM 9
- 98 Extension module 1, error 8
- 99 Extension module 2, error 8
- 100 2 clock time masters 3
- 102 Clock time master without backup 3
- 103 Communication error 8
- 105 Maintenance message 5
- 109 Supervision boiler temperature 6
- 109 Supervision boiler temperature 9
- 110 STB (SLT) lockout 6
- 110 STB (SLT) lockout 9
- 111 Temperature limiter safety shutdown 8
- 117 Water pressure too high 6
- 117 Water pressure too high 9
- 118 Water pressure too low 6
- 118 Water pressure too low 9
- 119 Water pressure switch has cut out 6
- 119 Water pressure switch has cut out 9
- 121 Flow temperature heating circuit 1 not reached 6
- 122 Flow temperature heating circuit 2 not reached 6
- 125 Maximum boiler temperature exceeded 9
- 126 DHW charging temperature not reached 6
- 127 DHW legionella temperature not reached 6
- 128 Loss of flame during operation 6
- 128 Loss of flame during operation 9
- 129 Wrong air supply 6
- 129 Wrong air supply 9
- 130 Flue gas temperature limit exceeded 6
- 130 Flue gas temperature limit exceeded 9
- 132 Gas pressure switch safety shutdown 6
- 133 Safety time for establishment of flame exceeded 6
- 133 Safety time for establishment of flame exceeded 9
- 146 Configuration error sensor/controlling elements 3
- 151 LMS14... error, internally 3
- 151 LMS14... error, internally 6
- 151 LMS14... error, internally 9
- 152 Parameterization error 3
- 152 Parameterization error 9
- 153 Unit manually locked 9
- 160 Fan speed threshold not reached 9
- 162 Air pressure switch does not close 9
- 164 Flow/pressure switch, heating circuit error 6
- 164 Flow/pressure switch, heating circuit error 9
- 166 Air pressure switch error, does not open 9
- 169 Sitherm Pro system error 3
- 169 Sitherm Pro system error 6
- 169 Sitherm Pro system error 9
- 170 Error water pressure sensor, primary side 6
- 170 Error water pressure sensor, primary side 9
- 171 Alarm contact 1 active 6
- 172 Alarm contact 2 active 6
- 173 Alarm contact 3 active 6
- 174 Alarm contact 4 active 6
- 176 Water pressure 2 too high 6
- 176 Water pressure 2 too high 9
- 177 Water pressure 2 too low 6

## Error

177 Water pressure 2 too low 9  
178 Temperature limiter heating circuit 1 3  
179 Temperature limiter heating circuit 2 3  
183 Unit in parameterization mode 6  
183 Unit in parameterization mode 9  
195 Maximum duration of the refill / charging exceeded 6  
195 Maximum duration of the refill /charging exceeded 9  
196 Maximum duration of the refill per week exceeded 6  
196 Maximum duration of the refill per week exceeded 9  
209 Fault heating circuit 3  
209 Fault heating circuit 6  
214 Monitoring of motor 6  
215 Fault fan air diverting valve 9  
216 Fault boiler 6  
216 Fault boiler 9  
217 Sensor error 3  
217 Sensor error 6  
217 Sensor error 9  
218 Pressure supervision 6  
218 Pressure supervision 9  
241 Flow sensor for yield measurement, error 6  
242 Return sensor for yield measurement, error 6  
243 Swimming pool sensor, error 6

## Error/LPB

260 217 Flow temperature 3, sensor error 3  
270 215 Temperature difference, heat exch too large 9  
317 214 Mains frequency outside permissible range 6  
320 217 DHW charging temperature, sensor error 6  
321 217 DHW outlet temperature, sensor error 6  
322 218 Water pressure 3 too high 6  
322 218 Water pressure 3 too high 9  
323 218 Water pressure 3 too low 6  
323 218 Water pressure 3 too low 9  
324 146 Input BX, same sensors 3  
325 146 Input BX/extension module, same sensors 3  
326 146 Input BX/mixing group, same sensors 3  
327 146 Extension module, same function 3  
328 146 Mixing group, same function 3  
329 146 Extension module/mixing group, same function 3  
330 146 Sensor input BX1 without function 3  
331 146 Sensor input BX2 without function 3  
332 146 Sensor input BX3 without function 3  
333 146 Sensor input BX4 without function 3  
335 146 Sensor input BX21 without function 3  
336 146 Sensor input BX22 without function 3  
339 146 Collector pump Q5 missing 3  
340 146 Collector pump Q16 missing 3  
341 146 Sensor B6 missing 3  
342 146 Solar charging sensor B31 missing 3  
343 146 Solar integration missing 3  
344 146 Solar controlling element buffer K8 missing 3  
345 146 Solar controlling element swimming pool K18 missing 3  
346 146 Solid fuel boiler pump Q10 missing 3  
347 146 Solid fuel boiler comparative sensor missing 3  
348 146 Solid fuel boiler address error 3  
349 146 Buffer storage tank return valve Y15 missing 3  
350 146 Buffer storage tank address error 3

## Error/LPB

351 146 Primary controller/system pump, address error 3  
352 146 Pressureless header, address error 3  
353 146 Sensor B10 missing 3  
371 209 Flow temperature heating circuit 3 6  
372 209 Temperature limiter heating circuit 3 3  
373 103 Extension module 3 8  
374 169 Sitherm Pro calculation 6  
374 169 Sitherm Pro calculation 9  
375 169 BV stepper motor 9  
376 169 Drift test limit value 3  
376 169 Drift test limit value 6  
376 169 Drift test limit value 9  
377 169 Drift test prevented 9  
378 151 Internal repetition 9  
382 129 Repetition speed 9  
384 151 Extraneous light 6  
384 151 Extraneous light 9  
385 151 Mains undervoltage 9  
386 129 Fan speed tolerance 6  
386 129 Fan speed tolerance 9  
387 129 Air pressure tolerance 6  
387 129 Air pressure tolerance 9  
388 146 DHW sensor no function 3  
426 151 Feedback flue gas damper 9  
427 152 Configuration flue gas damper 3  
429 218 Dynamic water pressure too high 6  
429 218 Dynamic water pressure too high 9  
430 218 Dynamic water pressure too low 6  
430 218 Dynamic water pressure too low 9  
431 217 Sensor primary heat exchanger 6  
431 217 Sensor primary heat exchanger 9  
432 151 Function earth not connected 9  
433 216 Temperature primary heat exchanger too high 6  
433 216 Temperature primary heat exchanger too high 9

**For detailed parameter setting and instructions, refer to**



## NAVISTEM 3000

Document number 500001310-A

**For service or spares please contact:-**

Hamworthy Heating Limited  
Fleets Corner  
Poole  
Dorset  
BH17 0HH

Phone Number	01202 662500
Fax Number	01202 665111
Service	01202 662555
Spares	01202 662525
Technical	01202 662527/662528